



palmOTDR

User's Manual

Shineway Technologies, Inc.
All rights reserved.

palmOTDR

CE FC

Notices

Copyright© 2014, ShinewayTech®, All rights reserved.

No part of this manual may be reproduced in any form or by any means (including electronic storage and retrieval or translation into a foreign language) without prior agreement and written consent from ShinewayTech® as governed by international copyright laws.

Warranty

The material contained in this document is subject to change without notice. ShinewayTech® makes no warranty of any kind with regard to this material, including, but not limited to, the implied warranties of merchantability and fitness for a particular purpose. ShinewayTech® shall not be liable for errors contained herein or for incidental or consequential damages in connection with furnishing, performance, or use of this material. The battery is a consumable part and is not subject to the palmOTDR warranty.

ISO9001 Certification

Produced to ISO9001 International Quality System Standard as part of ShinewayTech®, objective of continually increasing customer satisfaction through improved process control.

Safety Instructions

During each stage of operation of this instrument, please always observe the following safety instructions. Not taking any safety precautions or following the instructions will violate the safety standards of design, manufacturing and application of these instruments. In no case will Shineway Technologies bear the responsibilities for consequences incurred by violation of the following instructions.

GENERAL

This product is a Safety Class 1 instrument. The protective features of this product may be impaired if it is used in a manner not specified in the operation instrument.

Environmental conditions

It is designed to operate at a maximum relative humidity of 95% and at altitudes of up to 2000 meters. Refer to the specifications tables.

Before applying power

Verify that the product is set to match the available line voltage, the correct fuse is installed, and all safety precautions are taken. Note the instrument's external markings described under Symbols.

Do not operate in an explosive atmosphere

Do not operate the instrument in the presence of flammable gases or fumes.

Do not remove the instrument cover

Operating personnel must not remove instrument covers. Component replacement and internal adjustments must be made only by qualified service personnel.

Instrument that appears damaged or defective should be made inoperative and secured against unintended operation until they can be repaired by qualified service personnel.

Safety Terms Used in This Manual

WARNING!

The WARNING sign denotes a hazard. It calls attention to a procedure, practice, or the like, which, if not correctly performed or adhered to, could result in personnel injury. Do not proceed beyond a WARNING sign until the indicated conditions are fully understood and met.

CAUTION!

The CAUTION sign denotes a hazard. It calls attention to an operating procedure, or the like, which, if not correctly performed or adhered to, could result in damage to or destruction of part or the entire product. Do not proceed beyond a CAUTION sign until the indicated conditions are fully understood and met.

NOTE

The NOTE sign information that may be beneficial during the use and maintenance of the instrument.

WARNING!

- palmOTDR is a laser instrument. Users should avoid looking directly into the optic output. And the use of microscope or magnifier should also be avoided, for the use of such devices can focus a highly intense beam onto the retina, which may result in permanent eye damage
- Make sure that the optical fiber or cable is **not in use** and there is **no laser beam** in the fiber before testing via palmOTDR. Otherwise, it may result in imprecise test trace, even permanent damage for the palmOTDR

CAUTION!

Battery: Battery for this instrument is rechargeable NiMH battery. If unused for a long time, battery should be recharged before being used. If the instrument is left idle for more than two months, it should be recharged to maintain adequate battery volume. Do not recharge batteries for more than 8 hours. Do not take batteries out without technical staff's help. Do not expose batteries to fire or intense heat. Do not open or mutilate batteries. Avoid

touching the electrolyte in the batteries, which is corrosive and may cause injuries to eyes, skin or damage to clothes. For battery protection and performance.

External Power: palmOTDR from ShinewayTech supports external power. Power requirements: DC 13.8V/1.2A.

Laser Radiation: To avoid serious eye injury, never look directly into the optical outputs of fiber optic network equipment, test equipment, patch cords, or test jumpers.

- Always avoid looking directly into the optical output port, when the instrument is working
- Always replace protective dust cap on the detector port when the instrument is not being used
- Always avoid looking directly at unconnected end of optic fiber in testing and make the unconnected end pointing at a non-reflective object, if possible

Table of Contents

Notices	i
Warranty	i
Safety Instructions.....	ii
1.General Information	1
1.1 Scope of this Manual	1
1.2 Unpacking and Inspection	1
1.3 Introduction	1
2. Basic Operation	4
2.1 Foreword	4
2.2 Instrument Interfaces Instructions	4
2.3 Use of Batteries	5
2.4 Keypad Functions.....	6
3.Basic Information of palmOTDR.....	7
3.1 Principle of palmOTDR	7
3.2 Basic Definition and Classification of Events	7
3.2.1 Events.....	7
3.2.1.1 Reflection Events	8
3.2.1.2 Non-reflection Events	8
3.2.1.3 Inspection Events	8
3.3 Measurement Application of palmOTDR.....	9
3.3.1 Measurement Contents of palmOTDR.....	9
3.3.2 Trace Analysis of palmOTDR	9
3.4 Trace Display Screen of palmOTDR.....	10
3.4.1 Trace Display of palmOTDR	10
3.4.2 Information Window of palmOTDR	10
3.4.2.1 Measurement Trace Parameters	10
3.4.2.2 Events List.....	11
3.4.2.3 Information of Marker A/B	12
3.4.2.4 Information of Fiber.....	13
3.4.3 Menu Bar and Window of palmOTDR	13
3.4.3.1 Menu Bar and Icons of palmOTDR	13
3.4.3.2 Parameter Configuration on palmOTDR Menu Bar	14
3.4.3.2.1 Definitions of Measurement Parameters	15
3.4.3.2.2 Range Configuration	15
3.4.3.2.3 Pulse Width Configuration	16
3.4.3.2.4 Average Time Configuration	17
3.4.3.2.5 Wavelength Configuration.....	17

3.4.3.2.6 Measurement Mode Configuration.....	18
3.4.3.2.7 Power Meter and Laser Source Configuration (Optional only).....	18
3.4.3.2.8 Length Units Configuration.....	19
3.4.3.2.9 IOR Configuration.....	20
3.4.3.2.10 Scatter Coefficient Configuration.....	20
3.4.3.2.11 Non Reflection Threshold Configuration	21
3.4.3.2.12 Reflection Threshold Configuration.....	22
3.4.3.2.13 End Threshold Configuration	22
3.4.3.2.14 Delete File	23
3.4.3.2.15 Time Configuration	24
3.4.3.2.16 Auto off Configuration	24
3.4.3.2.17 Language Configuration.....	25
3.4.3.2.18 Contrast Adjustment of LCD Display	25
3.4.3.2.19 Color Mode Setting	25
3.4.3.2.20 Default Set.....	26
3.4.3.2.21 Help.....	26
3.5 Battery Recharge Status.....	28
4. Trace Measurement and Processing of Existing Traces	29
4.1 Instructions on GUI.....	29
4.2 Trace Measurement of palmOTDR	30
4.2.1 Trace Measurement- Connect Optical Fiber.....	30
4.2.2 Trace Measurement - Parameter Configuration	30
4.2.3 Trace Measurement- Auto	30
4.2.4 Trace Measurement - Manual.....	32
4.2.5 Trace Measurement -Reasons of Measurement Failures.....	32
4.3 Information Window	32
4.3.1 Switch between Information Window Items	33
4.3.2 Review Event List	33
4.3.3 Review Marker A/B Information	33
4.3.3.1 Switching between Marker A/B	33
4.3.3.2 Information between Marker A/B	33
4.4 Zoom in Trace Horizontally	33
4.5 Zoom out Trace Horizontally	34
4.6 Zoom in Trace Vertically	34
4.7 Zoom out Trace Vertically	34
4.8 Re-analyze the trace	34
4.9 Save Trace	35
4.10 Browse Saved Traces.....	35
4.11 Upload Saved Traces	36
4.12 Alter Measurement Parameters in Realtime Testing.....	38
4.13 Power Meter and Laser Source Settings (Optional)	38

5. Maintenance and Calibration.....47

Maintenance and Replacing of Batteries47

Cleaning of Interfaces.....48

- Effects of Cleaning Interfaces and Connectors.....48
- Safety instructions to be followed before cleaning.....48
- Tools for Cleaning Interfaces and Connectors.....48
- Preferred Procedure for Cleaning Interfaces and Connectors.....49

Calibration Requirements49

6. Warranty Information50

Terms of Warranty50

Exclusions50

Warranty Registration.....50

Returning Instruments50

Contacting Customer Service51

Table of Figure

Figure 2-1. Coping of palmOTDR	4
Figure 2-2. Operation Interface of palmOTDR	6
Figure 3-1. Reflection Event	8
Figure 3-2. Non-reflection Event	8
Figure 3-3. Trace Display Screen	10
Figure 3-4. Traces and Coordinates	10
Figure 3-5.(a) Measurement Trace Parameters	11
Figure 3-5.(b) Analysis Trace Parameters	11
Figure 3-6. Events List	12
Figure 3-7. Information of Marker A/B	12
Figure 3-8. Information of Fiber	13
Figure 3-9. (a) Parameter Configuration	14
Figure 3-9. (b) Parameter Configuration	14
Figure 3-10. Set Range	15
Figure 3-11. Pulse Width Configuration	16
Figure 3-12. Average Time Configuration	17
Figure 3-13. Wavelength Configuration	18
Figure 3-14. Measurement Mode Configuration	18
Figure 3-15. VFL Configuration	19
Figure 3-16. Length Units Configuration	20
Figure 3-17. IOR Configuration	20
Figure 3-18. Scatter Coefficient Configuration	21
Figure 3-19. Non Reflection Threshold Configuration	21
Figure 3-20. Reflection Threshold Configuration	22
Figure 3-21. End Threshold Configuration	23
Figure 3-22. Delete File	23
Figure 3-23. Time Configuration	24
Figure 3-24. Auto Off Configuration	24
Figure 3-25. Language Configuration	25
Figure 3-26. Contrast Adjustment of LCD Display	25
Figure 3-27. Color Mode Setting	26
Figure 3-28. Load Default	26
Figure 3-29. (a) Help	27
Figure 3-29. (b) Help	27
Figure 3-29. (c) Help	27
Figure 4-1. Power on Interface	29
Figure 4-2. Quick Reference	29
Figure 4-3.(a) Measuring	31
Figure 4-3.(b) Measuring	31
Figure 4-4. Trace Measurement of palmOTDR	32
Figure 4-5. Save Trace	35

Figure 4-6. Browse Saved Traces.....	36
Figure 4-7. Upload Saved Traces	37
Figure 4-8. Realtime Testing	38
Figure 5-1. Replacing Battery	47
Figure 5-2. Structure of Flange.....	49

1. General Information

1.1 Scope of this Manual

Thank you for purchasing ShinewayTech[®] instrument. Please read this manual carefully before using any of ShinewayTech[®] series fiber-optic instrument. Always observe the warnings and cautions appearing throughout this manual.

This manual contains the information necessary for proper operation and maintenance of ShinewayTech[®] palmOTDR, troubleshooting instructions as well as information regarding obtaining services.

All ShinewayTech[®] palmOTDR are carefully assembled and undergo a rigorous mechanical, electrical, and optical inspection prior to shipment. Beside the instrument, the package should also include a data transfer cable, a power adapter, a PC Analysis software installation disk and this users' manual etc. For detailed information, refer to the packing list

Upon receiving the instrument, please check for any obvious signs of physical damage that may have occurred during shipment. Report any damage to the shipping agent or the representative of Shineway Technologies Inc. immediately. Retain the original packing materials in case reshipment becomes necessary.

1.2 Unpacking and Inspection

This instrument has been carefully packed in accordance with standard shipping procedures. Examine the instrument for damage that may have occurred during shipment. If you find any damage or the instrument is not working, or if any of the following items are not included, please contact your representative of Shineway Technologies, Inc.

If necessary, you may contact Shineway Technologies, Inc via this email: support@shinewaytech.com.

1.3 Introduction

ShinewayTech[®] palmOTDR are the preferred choice for the measurement of optical fiber's specifications. With OTDR, you can make assessment of one single optical fiber or a whole optical fiber chain. Especially, you can directly observe loss and events distribution of optical fiber chain.

ShinewayTech[®] palmOTDR check the transmission quality of optic fiber through measurement of backward scattered lights. Standard organizations like International Telecom Union (ITU) define backward scattered lights as effective analysis means of measurement of optical fiber loss. Backward scattering is also the only effective way of connector inspection, which can be applied to measure the length of optical fiber, too. Therefore, palmOTDR is a useful tool for optical fiber manufacturing, installation and maintenance.

palmOTDR works through reviewing “events” in optical fiber (for example, irregularities and connectors), which is quite helpful for quality control for those who are in charge of optical fiber manufacturing, installation and maintenance. palmOTDR can help identify the irregularities in optical fiber, locate them, and measure their attenuation, relevant loss and their homogeneity.

palmOTDR is more helpful for field operation. It can help to check the qualification of optical fiber chain circuit on a regular basis. For the purpose of future maintenance, transmission quality and condition of optical fiber need to be recorded and stored, which includes measurement of optical path, total loss, and loss of all tie-ins and connectors.

Besides, palmOTDR are easy to use, small and compact. According to the ergonomics, they are designed to fully embody the user's convenience with its large LCD display and graphical interface. They can save and transfer the measurement curves data to a PC by the provided software for further analyzing, reporting and printing.

palmOTDR features by:

- Basic applications:
 - a) Measure the length of optical fiber and cable
 - b) Measure the distance between two points on optical fiber and cable
 - c) Locate faults and ruptures of optical fiber and cable
 - d) Display **distribution curve** of optical fiber and cable loss
 - e) Measure **attenuation coefficient** of optical fiber and cable
 - f) Measure loss between two points on optical fiber and cable
 - g) Measure loss of tie-ins
 - h) Measure reflection of **reflection events** of optical fiber and cable

For a specific event (Transmission quality changed due to faults caused by welding, connector, bending etc.), the following measurements can be carried out with palmOTDR:

- a) For each event: distance, loss and reflection
 - b) For each section of optical fiber: length and loss of dB or dB/Km
 - c) For the whole optical fiber chain: length and loss of dB
- Large Colorful LCD display with auto or manual adjustment of contrast
 - Backlight LCD display supports night operation

- Easy operation with trace graphic display
- Trace storage function
- RS232/USB Data upload port
- PC analysis software for analyzing and reporting previously stored data
- Auto off function conserving battery life
- DC/AC power supply
- Auto recharging, over 8 hours operation for one charge.

2. Basic Operation

2.1 Foreword

This part introduces the basic operation on the palmOTDR. Specific operations of each type instrument are elaborated in Chapter 3 of this manual. Please read this manual carefully for optimal operation. Should you encounter any problems during operation, you are welcome to contact the technical staff of our company or representatives.

2.2 Instrument Interfaces Instructions

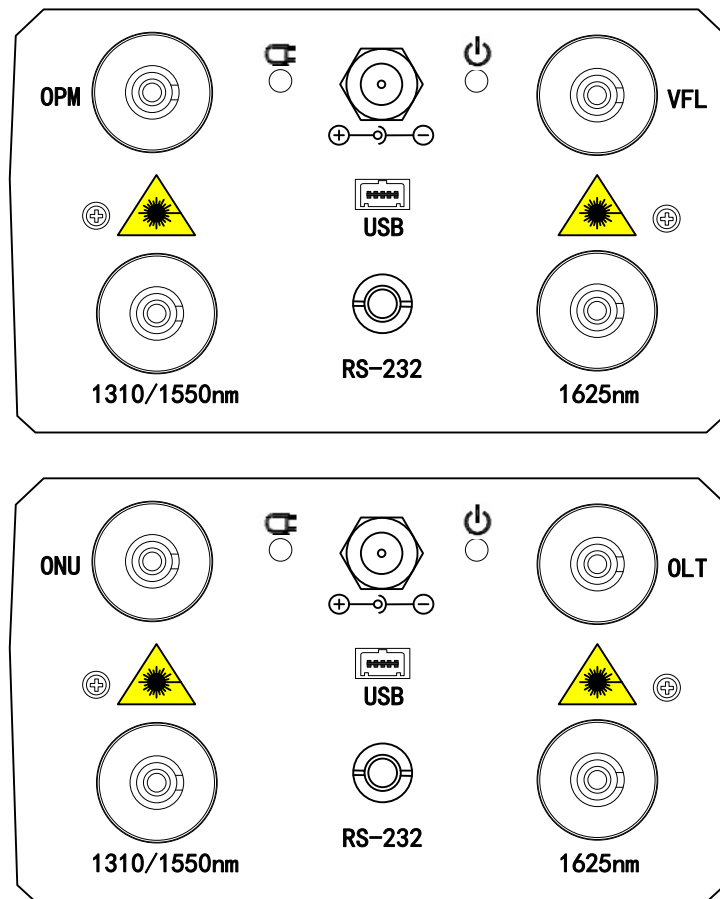

Figure 2-1. Typical Copings of palmOTDR
(Coping of palmOTDR may vary according to different models and configurations)

- **OTDR/VFL** (VFL is standard on S20BE, S20C/N and S20D/N; optional on M20AE, S20AE, S20C/P, S20C/X, S20C/E, P11C and P13C)
Fiber optic output for OTDR and VFL, a FC/PC (interchangeable SC, ST) connector is used for optic interface.
- **ONU/OLT** (Available on P11C and P13C)
Fiber optic ports of PON Power Meter module on palmOTDR-P series.
- **AC Power Jack**
Power adapter jack requirements: 13.8V DC@1.2A.
- **Data Transfer Port**
For all types, there are USB interface and RS232 interface. This interface is used to transfer saved traces in the instrument to a PC for further analysis by associated trace manager.
- **Power/Charge Indicator**
When measurement power on or charging, the relevant indicator will be lightened.

CAUTION!

Invisible laser radiation

Please always avoid looking directly at the optical output or stare at laser beam.

2.3 Use of Batteries

Battery for ShinewayTech[®] palmOTDR is NiMH battery.

- **Cautions during Operation:**
 - The following may bring auto power off of the instrument:
 - The instrument will be auto power off when there is insufficient power during operation and low power will be shown on the LCD.
 - If unused for a long time and cause insufficient power, the instrument will be power off several seconds after powering on so as to protect the batteries in case of excessive discharging. The inside batteries should be recharged immediately through adapter.
 - Please charge only when battery remaining capacity is low, or adapter should be unplugged. Irregular charging operation may seriously shorten battery life.
- **Cautions in Recharge:**
 - Quick charge is needed first and then switch to trickle charge after the voltage reaches a predefined Figure. Quick charge temperature is +5~+45°C, and trickle charge temperature is 0~+55°C, suitable for indoors. Battery will not be full or be damaged if the charging temperature is beyond the above range, which may shorten batter life.
 - 3 hours for quick charge;
 - Do not charge for over 8 hours

2.4 Keypad Functions



Figure 2-2. Operation Interface of palmOTDR

[On/Off]

Power on or off



[Run/Stop]

Under GUI, Press to start measurement.
While testing, press this key to stop measurement

[Enter]

- Under GUI, press this key to confirm the current operation
- Together with [Shift/↻], can browse the event list downwards

[▲] [▼]

Main functions:

- Move menu bar in menu operation
- Highlight the icon to be operated
- Adjust parameter in parameter configuration
- Together with [Shift/↻], can zoom out or zoom in trace vertically

[◀] [▶]

Main functions:

- Select parameter to be adjusted in parameter configuration
- Move marker leftwards or rightwards in Trace operation
- Turn page while in Help sub-menu
- Together with [Shift/↻], can zoom out or zoom in trace horizontally

[↶]

Main functions:

- Read help when power on
- Cancel the current operation
- Exit menu configuration
- Switch between information Windows
- Together with [Shift/↻], can review the event list upwards

[Shift/↻]

This is the hot key to activate the integration function by being pressed together with other keys. Besides, by pressing this key singly under the GUI of displaying trace, the trace can be resumed to the original size without any zoom

3. Basic Information of palmOTDR

3.1 Principle of palmOTDR

OTDR (Optical Time Domain Reflectometer) is a measurement instrument for identifying optic fiber transmission features. The instrument is mainly used to measure attenuation of a whole optic fiber chain and provide attenuation details relating to length, namely detect, locate and measure any event in optic fiber chain (events refer to faults caused by welding, connectors, and bending whose transmission change can be measured). Its non-destructive, one-end connection and rapid measurement have made the palmOTDR an indispensable tool for manufacture, construction, and maintenance of optic fiber.

The faults and heterogeneity of optic fiber itself cause **Rayleigh scattering** of light pulse transmitted in optic fiber. Part of light pulse is scattered in the reverse direction, and this is called **Rayleigh backward scattering**, which actually provides attenuation details relating to length.

Information relating to distance is obtained through time information (that's the reason why there is "time Domain" in the name of OTDR). **Fresnel reflection** occurs at the boundary between two media of different **IOR** (for example, connections of faults, connectors, or optic fiber end). This reflection is used to locate the discontinuous points on optic fiber. The magnitude of reflection depends on the difference between IOR and the smoothness of boundary.

OTDR sends out a light pulse into connected optic fiber, and receive reflections of events and backward scattering power of pulse in time. **Locus** will be displayed on LCD. The y-axis is dB value of backward scattering power, and the x-axis is the distance.

3.2 Basic Definition and Classification of Events

3.2.1 Events

Events refer to any abnormal points causing attenuation or sudden change of scattering power besides the normal scattering of optic fiber, which include all kinds of losses like bending, connections and ruptures.

Events points displayed on LCD are abnormal points that cause traces to deviate from straight line.

Events can be classified as reflection events and non-reflection events.

3.2.1.1 Reflection Events

When some pulse energy is scattered, reflection events happen. When reflection event occurs, peak shows on trace, as shown in Figure 3-1.

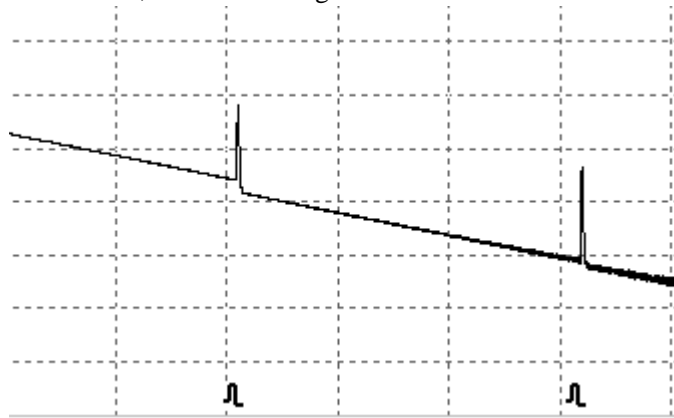

Figure 3-1. Reflection Event

3.2.1.2 Non-reflection Events

Non-reflection events happen at certain points where there is some optic loss but no light scattering. When non-reflection event occurs, a power decline shows on trace, as in Figure 3-2.

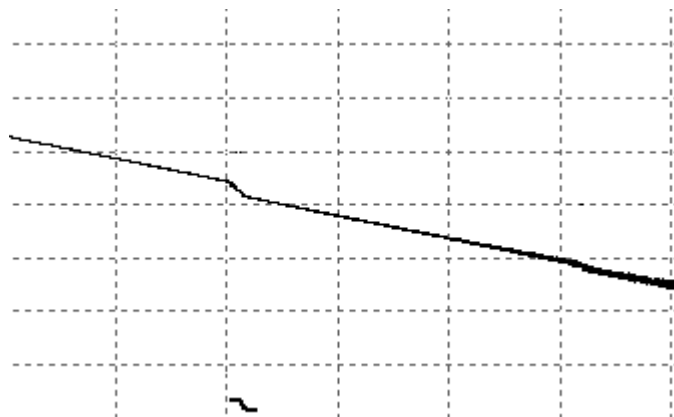

Figure 3-2. Non-reflection Event

3.2.1.3 Inspection Events

palmOTDR sends off a light pulse into the optic fiber to be inspected, and then receive returning light signals, and starts calculating the “event” distance. The farther the distance is, the longer time need for scattered light to be received by the instrument. Event distance can be calculated according to the time of receiving events signals.

Through inspection of scattered signals, properties of optic fiber, connectors, tie-ins can be identified.

3.3 Measurement Application of palmOTDR

palmOTDR displays power relating to distance of returning signals. This information can be used to identify the main properties of an optic fiber chain.

3.3.1 Measurement Contents of palmOTDR

- Event location(distance),end or rupture of optic fiber chain
- Attenuation coefficient of fiber
- Loss of a single event (for example, one optic tie-in), or total loss from upper end to end
- Range of a single event like reflection of connectors (or grade of reflection)
- Auto measurement of cumulative loss of a single event

3.3.2 Trace Analysis of palmOTDR

The trace analysis of palmOTDR is fully automatic. The trace locates:

- Reflection events of connections and mechanic tie-ins
- Non-reflection events (usually at welding tie-ins)
- End of optic fiber

Through scanning the first loss event that is larger than end threshold, end of optic fiber can be identified.

- Events list: event type, loss, reflection and distance.

3.4 Trace Display Screen of palmOTDR

Trace displays on palmOTDR screen, as in Figure 3-3.

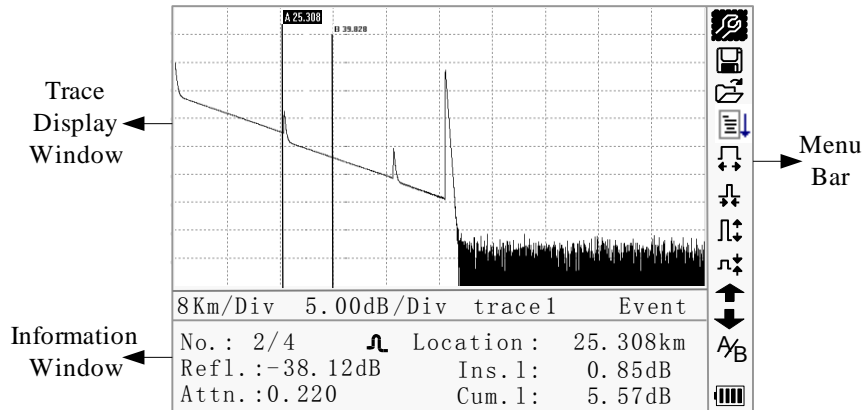

Figure 3-3. Trace Display Screen

3.4.1 Trace Display of palmOTDR

This window displays the trace after one measurement.

Definition of Trace: After one measurement, reflection power diagram will be displayed as distance function. This diagram is referred to as trace.

Trace of palmOTDR displays measurement result in a graphic form. The y-axis stands for power, and the x-axis stands for distance, as shown in Figure 3-4.

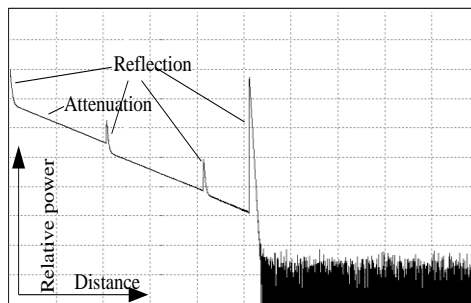

Figure 3-4. Traces and Coordinates

3.4.2 Information Window of palmOTDR

Contents of this window: measurement parameters, events list, marker A/B and analysis parameters.

3.4.2.1 Measurement Trace Parameters

Important measurement and analysis parameters always display in the information window, as shown in Figure 3-5.(a), (b):

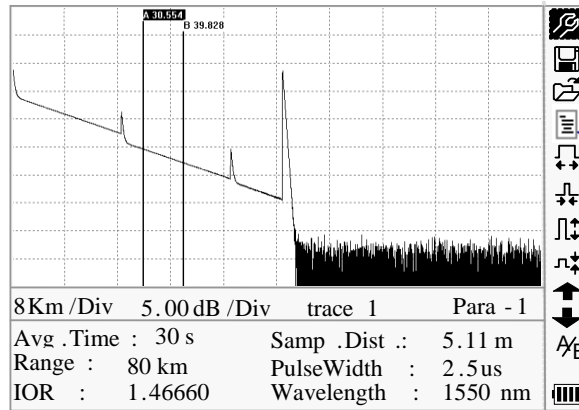

Figure 3-5.(a) Measurement Trace Parameters

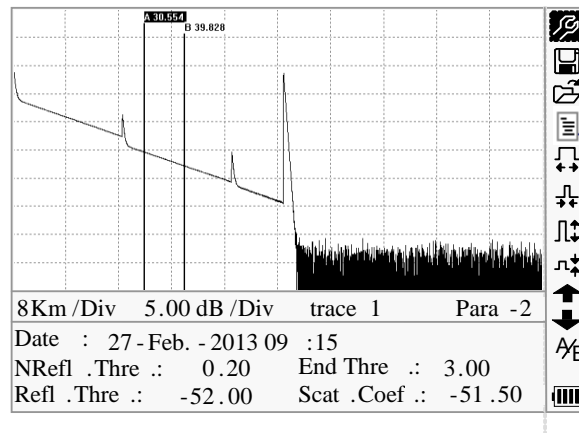

Figure 3-5.(b) Analysis Trace Parameters

For definitions and configurations of items in Figure 3-5.(a) (Avg. time, sample distance, Range, IOR, wave length and pulse width) showed in the interface, please refer to parameter configuration.

For definitions of items in Figure 3-5.(b) (date, reflection threshold, non-reflection threshold, end threshold, scattering coefficient), please refer to parameter configuration.

3.4.2.2 Events List

To indicate the location of events inspected. Any defined posts will be displayed in event list, for example, non-reflection event like welding points and reflection event like connectors, as shown in Figure 3-6.

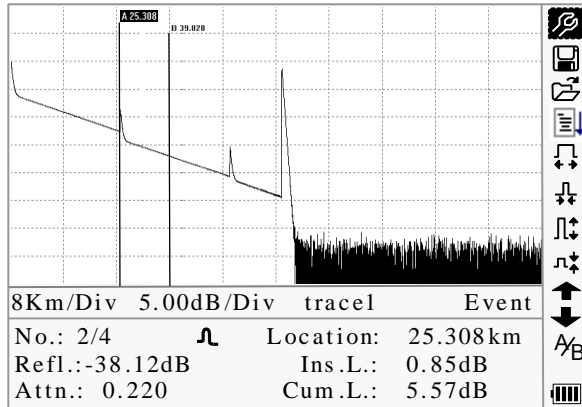

Figure 3-6. Events List

No: Event sequence No;

Four types of events:

└ Begin end; \curvearrowright Reflection event; \dashv Fiber end; \lrcorner Attenuation event;

Loc.: Distance from beginning point to event;

Refl.: Magnitude of reflection;

Insl.: Loss of Inserted event;

Attn.: Attenuation characteristic from one event point to the current event.

Cuml.: Cumulative loss, calculating from beginning point to the current event.

3.4.2.3 Information of Marker A/B

Marker is used to mark and analyze a single event, trace section and distance. Distance, attenuation, loss at marker or between markers will be displayed in information of markers, as shown in Figure 3-7.

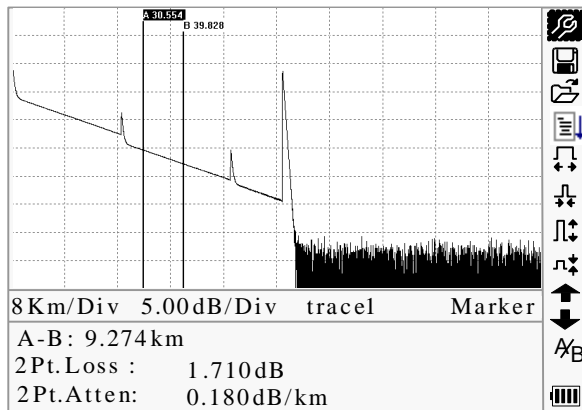

Figure 3-7. Information of Marker A/B

The following parameters are measured between marker A and B. When you change either marker, record will change accordingly.

- “A-B”: Distance between two markers

- “2 points loss”: Loss between two markers; power difference between two markers
- “2 points attenuation”: 2 points loss of unit length

The specific operations of the above are to be elaborated afterwards.

3.4.2.4 Information of Fiber

Information of fiber includes total attenuation, length and loss of the tested fiber. As shown in figure 3-8.

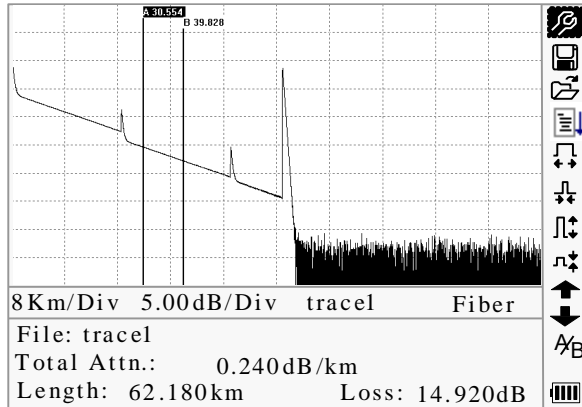

Figure 3-8. Information of Fiber

3.4.3 Menu Bar and Window of palmOTDR

3.4.3.1 Menu Bar and Icons of palmOTDR

No.	Icons	Meanings
1		Parameter configuration
2		Save file
3		Open file
4		Re-analyze the trace
5		Zoom in trace horizontally
6		Zoom out trace horizontally
7		Zoom in trace vertically
8		Zoom out trace vertically
9		Switching between markers
10		Review events list upwards

No.	Icons	Meanings
11	↓	Review events list downwards
12	🔋	Battery power indicator

NOTE

- Under Help Menu, only No.1 and 3 are operational
- In the process of measurement, all function on menu bar will be disabled
- No.3, 4, 5, 6, 7, 8 and 9 are tools for trace analysis; No.10 and 11 are tools for reviewing events list
- No.1 is elaborated in Figure 3.4.3.2

3.4.3.2 Parameter Configuration on palmOTDR Menu Bar

Correct parameter configuration is a necessity for accurate measurement; therefore, necessary configuration must be performed before using the instrument. The following are examples of palmOTDR-S20C.

Use [▲] and [▼] to highlight ⌘, i.e. parameter configuration, then press [Enter], as shown in Figure 3-9; Press [↩] to exit.

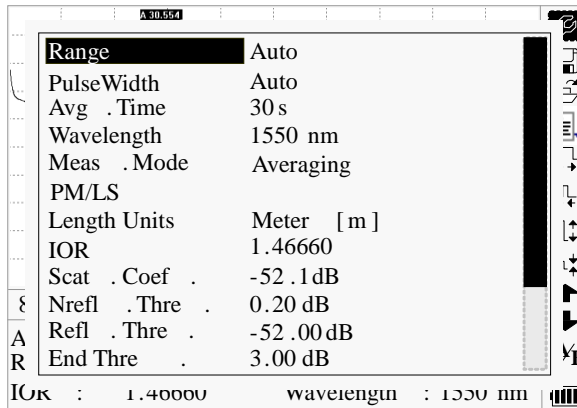

Figure 3-9. (a) Parameter Configuration

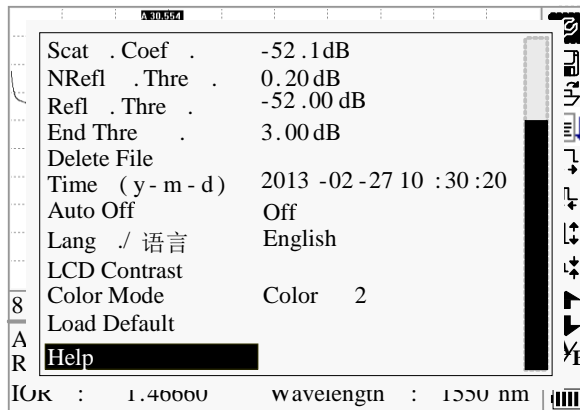

Figure 3-9. (b) Parameter Configuration

3.4.3.2.1 Definitions of Measurement Parameters

Parameter	Definition of Parameter
Range	Length of optic fiber relevant to the trace
Pulse Width	Width of laser pulse sending out from OTDR to optic fiber
Average Time	To select suitable testing time.
Wave length	To select laser wave length for measurement
Measurement Mode	To select mode for measurement
VFL	Power on or off visible laser(For B/N, C/N & D/N only)
Length Units	To select length units
IOR	IOR of optic fiber which affects the transmission speed of laser
Scatter Coefficient	Which affects backward scatter power of laser in fiber
Non reflection threshold	Events whose insertion loss is greater than the threshold displays here
Reflection threshold	Reflection events GE the threshold will be displayed.
End threshold	The first event with insertion loss GE the threshold is considered the end of fiber, and all following events will be ignored
Delete Files	Delete stored trace data in the instrument
Time	Show current system time
Auto Off	On or off of Auto off function
Lang./语言	Choose the language
LCD contrast	Adjust the contrast of LCD to select
Color mode setting	Select suitable displaying color setting
Load Default	Set all parameters to factory setting
Help	Show help files (Quick Reference)

3.4.3.2.2 Range Configuration

Generally, range will be set according to actual length of optic fiber, so as to insure the accuracy of measurement.

Under the menu of parameter configuration, use [▲] and [▼] to highlight “Range”; Press [Enter] to enter, as shown in Figure 3-10; press [↶] to exit.

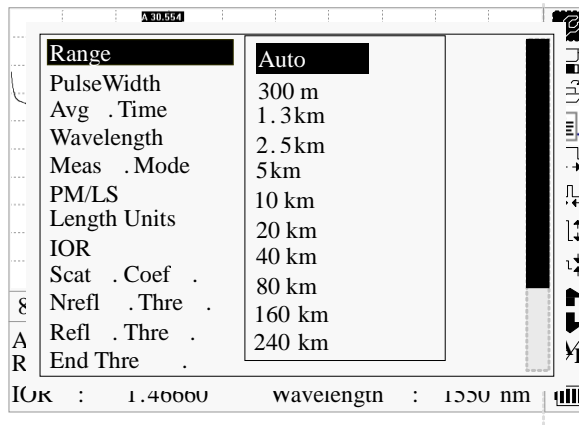

Figure 3-10. Set Range

Use [▲] and [▼] to select adequate range; Press [Enter] to confirm.

NOTE

- “Auto” means the automatic measurement. When this function is selected, the instrument will automatically make an intelligitized selection of adequate range and pulse width for measurement. The whole process of measurement does not need any intervention of the operator
- “Auto” means the default setting

3.4.3.2.3 Pulse Width Configuration

The selection of pulse width affects the dynamic range and resolution of measurement trace. With narrow pulse width, there will be higher resolution and smaller dead zone, however, the dynamic range will be decreased. On the contrary, wide pulse width can bring higher dynamic range and measure comparatively long distance, but resolution and dead zone will be affected. Therefore, users should make choice between dynamic range and dead zone.

There will be different pulse width options for reference according to different range of distance being chosen.

Under menu of parameter configuration, use [▲] and [▼] to highlight “PulseWidth”; Press [Enter] to select as shown in Figure 3-11. Press [↩] to exit.

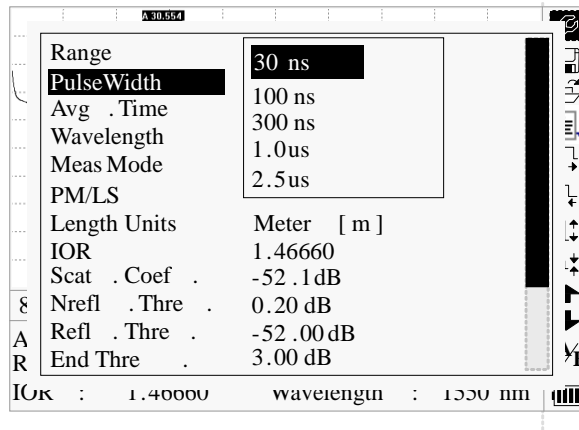

Figure 3-11. Pulse Width Configuration

Use [▲] and [▼] to highlight pulse width; Press [Enter] to confirm.

NOTE

- “Auto” means the default setting

- When Range is set to “Auto”, pulse width will automatically become “Auto”

3.4.3.2.4 Average Time Configuration

Average time will affect the SNR directly. The longer the average time is, the higher SNR is, as well as dynamic range. Therefore, in case of measurement of long-distance optic fiber, long average time should be selected in order to review events at long-distance end.

Under parameter configuration, use [▲] and [▼] to highlight “Average time”; press [Enter] to confirm, as shown in Figure 3-12. Press [↶] to exit.

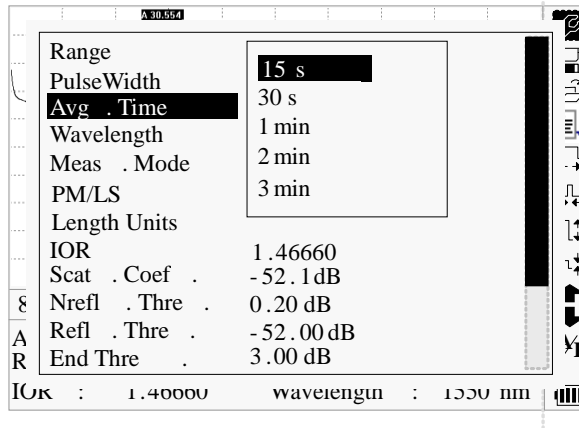

Figure 3-12. Average Time Configuration

Use [▲] and [▼] to highlight the desired time; and press [Enter] to confirm.

NOTE

- There are 5 levels of predefined average time: 15s, 30s, 1min, 2min and 3min
- The default setting is 30s

3.4.3.2.5 Wavelength Configuration

Under parameter configuration, use [▲] and [▼] to highlight “wavelength”; press [Enter] to change wavelength, as shown in Figure 3-13.

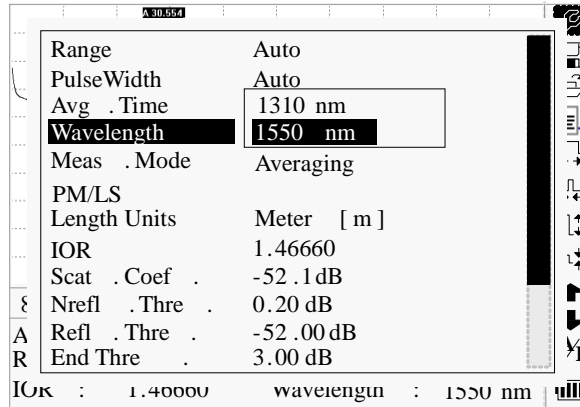

Figure 3-13. Wavelength Configuration

3.4.3.2.6 Measurement Mode Configuration

There are two kinds of measurement mode: Averaging and Real time mode. Under Real time Mode, palmOTDR will undertake realtime measurement for the connector of exterior fiber and refurbish the measure trace. While under Real time Mode, press key “Run/Stop” to stop, otherwise it will measure all along. Under Averaging Mode, palmOTDR will average the data within the measure time which is set by user. While exceeding the set time, it will stop automatically and display the result. Generally, we suggest Averaging Mode. Under menu of parameter configuration, use [▲] and [▼] to highlight “Measurement Mode”; Press [Enter] to choose Averaging mode or Realtime mode, as shown in Figure 3-14. Press [↶] to exit.

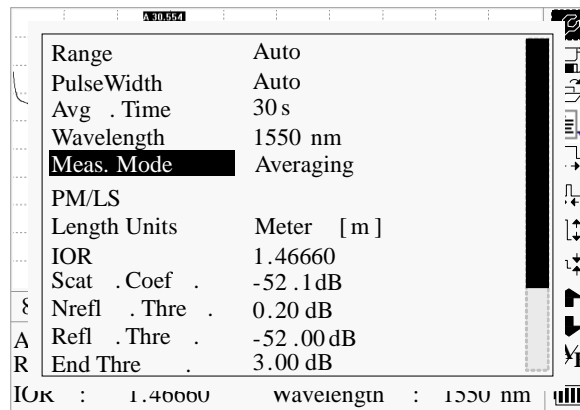

Figure 3-14. Measurement Mode Configuration

3.4.3.2.7 Power Meter and Laser Source Configuration (Optional only)

Under parameter configuration, use [▲] and [▼] to highlight “PM/LS” and press [Enter] to enter PM/LS interface as shown in Figure 3-15a/b/c (Depending configurations). Please refer to 4.13 for details.

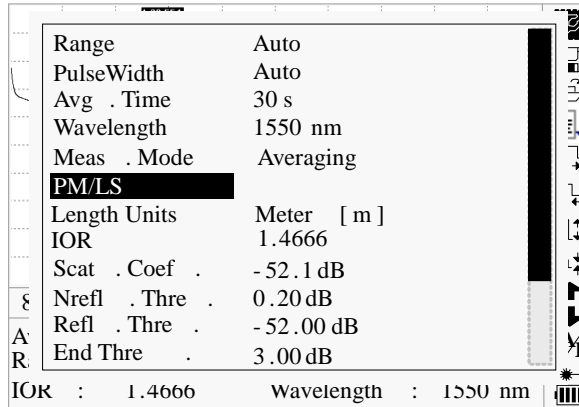

Figure 3-15a. PM/LS Option



Figure 3-15b. PM/LS Interface

1310nm	PASS	PPM
-3.15	dBm	
1490nm	WRNG	
-20.76	dBm	
1550nm	PASS	
-3.29	dBm	
0.beijing	Save	

Figure 3-15c. PPM Interface

3.4.3.2.8 Length Units Configuration

Under the parameter configuration menu use [▲] and [▼] to highlight “Length Units”; press [Enter] to select the desired units of measurement, as in Figure 3-16. Press [↶] to

exit.

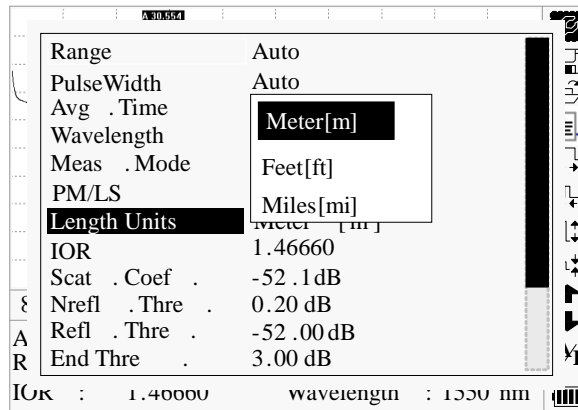

Figure 3-16. Length Units Configuration

3.4.3.2.9 IOR Configuration

IOR is a key factor to affect the speed of laser transmission in optic fiber; and in this case, IOR configuration has direct impact on the accuracy of measurement. Generally speaking, the IOR parameter is provided by optic fiber manufacturer, and it can be set to the accuracy of four digits after decimal point between 1.00000-2.00000.

Under parameter configuration, use [▲] and [▼] to highlight “IOR”; and press [Enter] to enter, as in Figure 3-17. Press [↶] to exit.

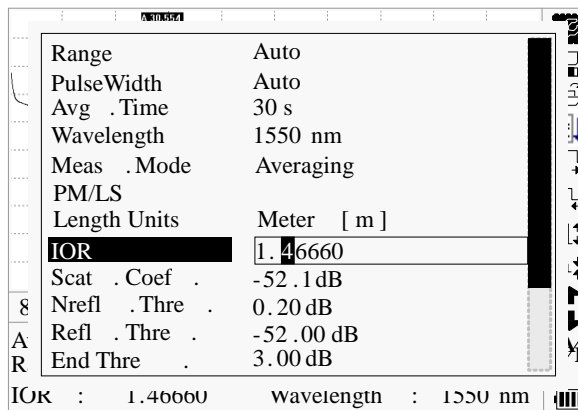

Figure 3-17. IOR Configuration

Use [◀] and [▶] to adjust the position of highlights; use [▲] and [▼] to change the digits. After setting, press [Enter] to confirm.

3.4.3.2.10 Scatter Coefficient Configuration

Scatter coefficient determines the value of backward scatter power. The configuration affects the calculation of reflection value.

Under parameter configuration, use [▲] and [▼] to highlight “Scatter coefficient”; press [Enter] to enter, as shown in Figure 3-18. Press [↶] to exit.

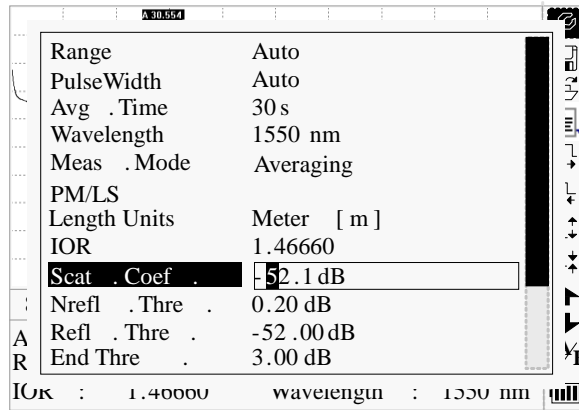

Figure 3-18. Scatter Coefficient Configuration

Use [◀] and [▶] to adjust the position of highlights; use [▲] and [▼] to change the digits. After setting, press [Enter] to confirm.

3.4.3.2.11 Non Reflection Threshold Configuration

This configuration has direct impact on the listing of insertion loss events. Only events GE this threshold will be listed.

Under parameter configuration, use [▲] and [▼] to highlight “Non reflection threshold”; press [Enter] to enter, as shown in Figure 3-19. Press [↶] to exit.

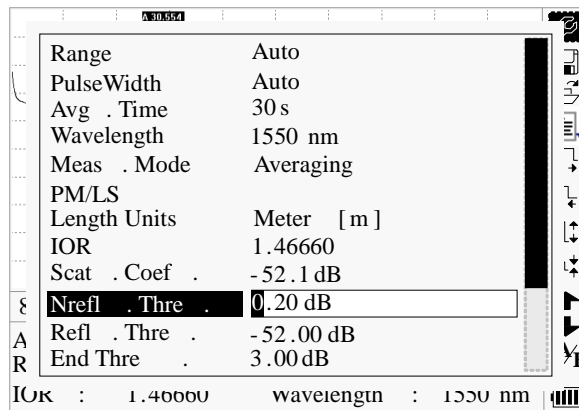

Figure 3-19. Non Reflection Threshold Configuration

Use [◀] and [▶] to adjust the position of highlights; use [▲] and [▼] to change the digits. After setting, press [Enter] to confirm.

NOTE

The default setting is 0.2dB

3.4.3.2.12 Reflection Threshold Configuration

This configuration has direct impact on reflection events listing. Only reflection events GE this threshold will be displayed in events list.

Under parameter configuration, use [▲] and [▼] to highlight “reflection threshold”; press [Enter] to enter, as shown in Figure 3-20. Press [↶] to exit.

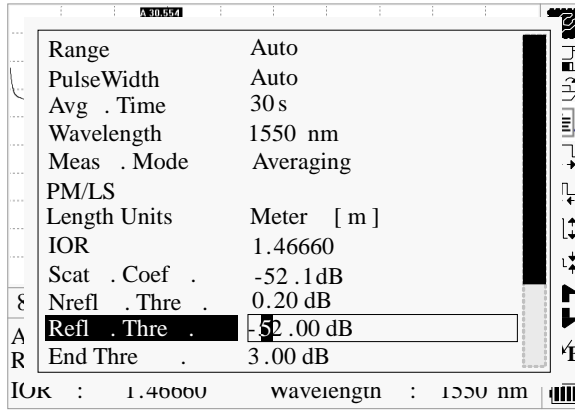

Figure 3-20. Reflection Threshold Configuration

Use [◀] and [▶] to adjust the position of highlights; use [▲] and [▼] to change the digits. After setting, press [Enter] to confirm.

NOTE

The default setting is -52.00dB

3.4.3.2.13 End Threshold Configuration

This threshold is the end threshold of optic fiber. If the end threshold equals 3.0dB, then the first event with insertion loss GE 3dB will be considered as the end of the optic fiber. If the value is set to 0dB, there will be no end threshold.

Under parameter configuration, use [▲] and [▼] to highlight “End threshold”; press [Enter] to enter, as shown in Figure 3-21. Press [↶] to exit.

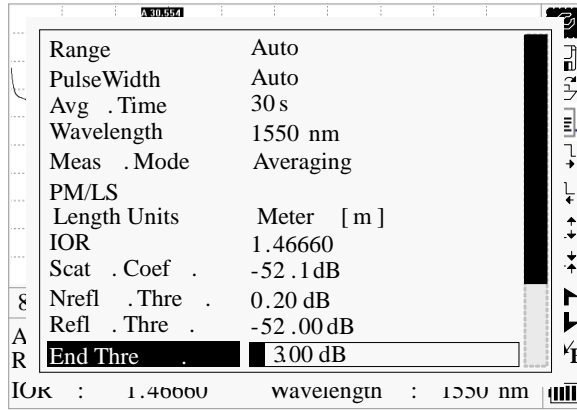

Figure 3-21. End Threshold Configuration

Use [◀] and [▶] to adjust the position of highlights; use [▲] and [▼] to change the digits. After setting, press [Enter] to confirm.

NOTE

The default setting is 3.00dB

3.4.3.2.14 Delete File

This function is designed to delete saved traces.

Under parameter configuration, use [▲] and [▼] to highlight “Delete file” ; press [Enter] to enter, as shown in Figure 3-22. Press [↶] to exit.

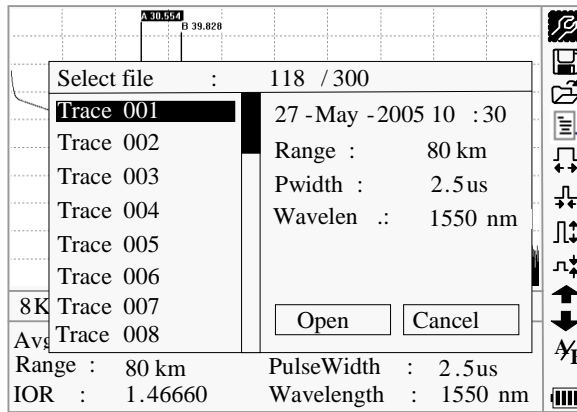

Figure 3-22. Delete File

Press [▲] and [▼] to choose the files to be deleted, and then press [Enter] to confirm. Users can delete one or several files by one time. Press [◀] and [▶] to choose [Delete]. Press [Enter], according to the instruction, choose “Yes” to delete; choose “No” to not delete. If choose [Cancel], it will exit the file delete menu.

3.4.3.2.15 Time Configuration

Time configuration is used to change system time.

Under parameter configuration, use [▲] and [▼] to highlight "Time"; press [Enter] to change, as shown in Figure 3-23. Press [↶] to exit.

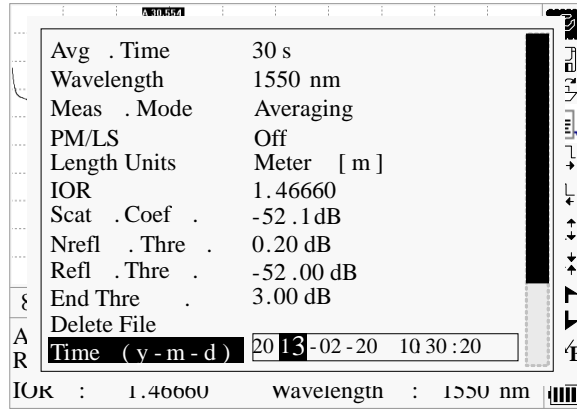

Figure 3-23. Time Configuration

Use [◀] and [▶] to adjust the position of highlights; use [▲] and [▼] to change the digits. After setting, press [Enter] to confirm.

3.4.3.2.16 Auto off Configuration

This function is designed for conserving battery power. If auto off is on, the instrument will auto power off within 5 minutes of idleness.

Under parameter configuration, use [▲] and [▼] to highlight "Auto off"; press [Enter] to switch, as shown in Figure 3-24. Press [↶] to exit.

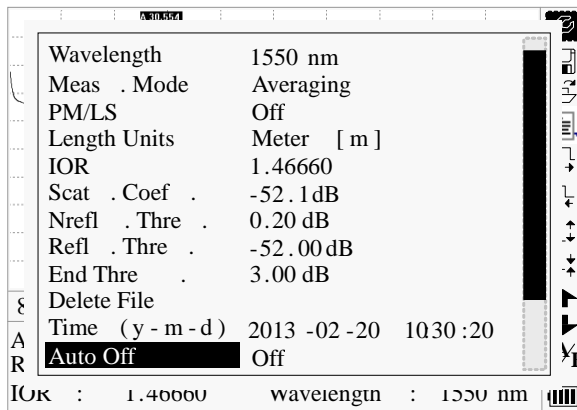

Figure 3-24. Auto Off Configuration

NOTE

The default setting is “auto off” on

3.4.3.2.17 Language Configuration

There are two language options: English and Chinese.

Under parameter configuration, use [▲] and [▼] to highlight “Lang./语言”; press [Enter] to switch, as shown in Figure 3-25. Press [↶] to exit.

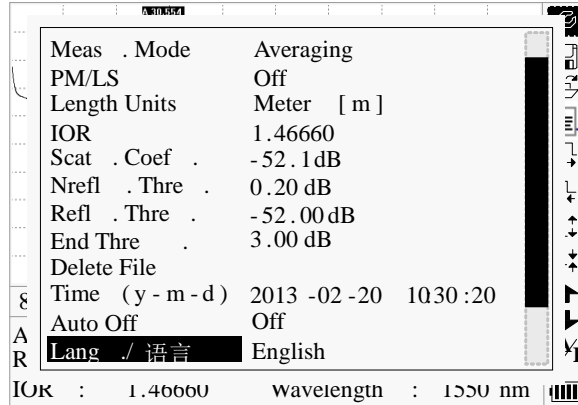

Figure 3-25. Language Configuration

3.4.3.2.18 Contrast Adjustment of LCD Display

The contrast of LCD has been adjusted. And users can adjust the contrast according to personal visual habits.

Under parameter configuration, use [▲] and [▼] to highlight “LCD Contrast”; press [Enter] to adjust, as shown in Figure 3-26. Press [↶] to exit.

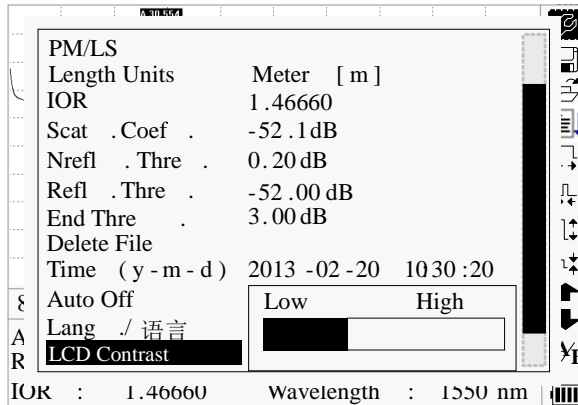

Figure 3-26. Contrast Adjustment of LCD Display

Use [◀] and [▶] to adjust contrast, and press [Enter] to confirm.

3.4.3.2.19 Color Mode Setting

Choose the different displaying color scheme according to the user's fancy.

Under parameter configuration, use [▲] and [▼] to highlight “Color mode”, press [Enter] to choose different mode. Press [↶] to exit, as shown in Figure 3-27.

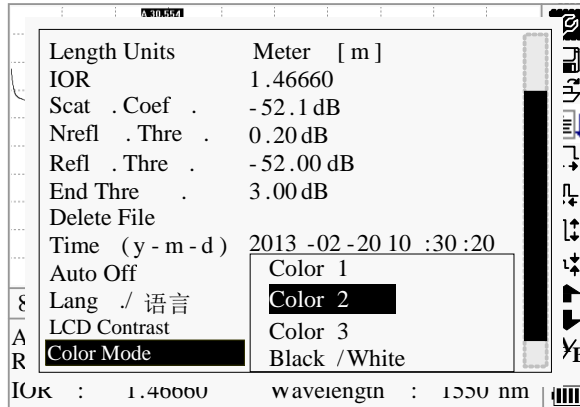

Figure 3-27. Color Mode Setting

Use [▲] and [▼] to highlight suitable color mode setting; press [Enter] to confirm the selection.

3.4.3.2.20 Default Set

This function is used to set OTDR parameters to factory settings. Those parameters include: range, pulse width, average time, IOR, non-reflection threshold, reflection threshold, end threshold, and scatter coefficient. Under parameter configuration, use [▲] and [▼] to highlight “Load default”; press [Enter] to enter, as shown in Figure 3-28. Press [↶] to exit.

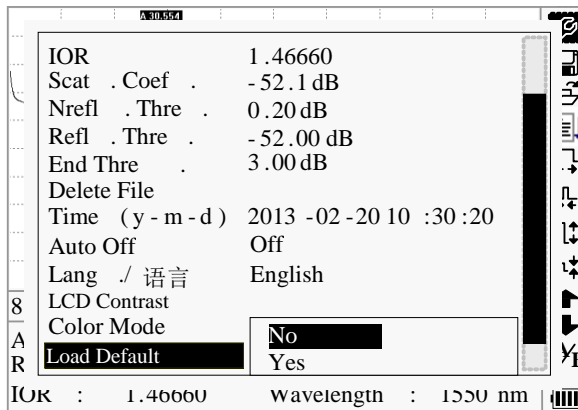

Figure 3-28. Load Default

Use [▲] and [▼] to highlight “yes” or “no”; press [Enter] to confirm.

3.4.3.2.21 Help

Users can get the quick reference via **Help** menu.

Under parameter configuration, Use [▲] and [▼] to highlight “Help”; Press [Enter] to

enter, as shown in 3-29.(a)、(b)、(c). Press [↵] to exit.

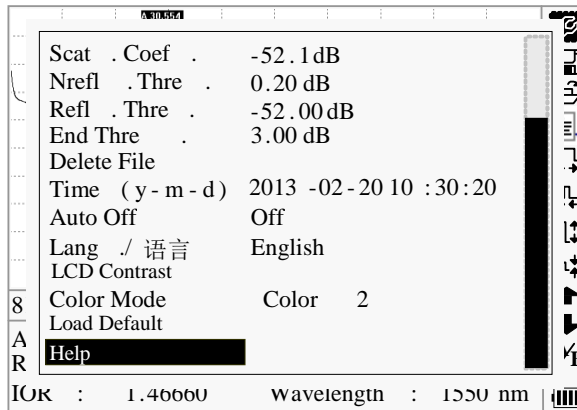

Figure 3-29. (a) Help

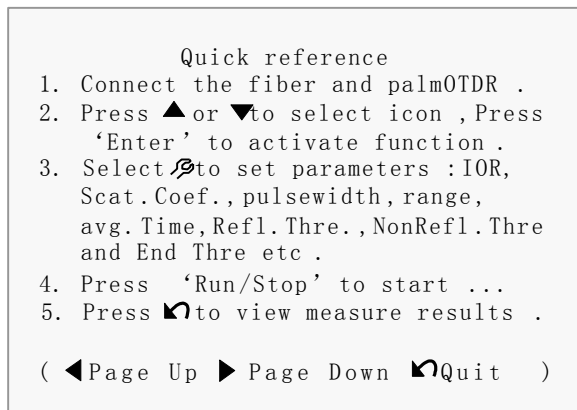

Figure 3-29. (b) Help

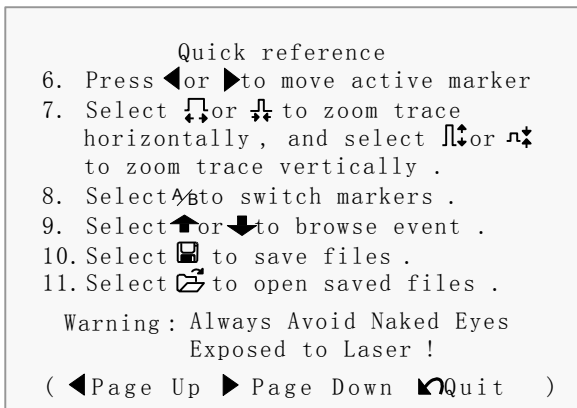



Figure 3-29. (c) Help

3.5 Battery Recharge Status

When the instrument is power off and powered through AC/DC adapter, the “CHARGE” indicator on the coping (Figure 1.) will turn on. When batteries are fully recharged, the indicator will turn off.

When the instrument is power on and powered through AC/DC adapter, the inside batteries are automatically recharged. The meanings of signals are as follows:

 The batteries are being recharged;

 The batteries are fully recharged.

When the instrument is powered by inside rechargeable batteries, power volume of batteries is shown on the LCD:

 No power;

 Low power;

 Half power;

 More than half power;

 Full power.

4. Trace Measurement and Processing of Existing Traces

4.1 Instructions on GUI

After power on, power on interface displays on the LCD, as shown in Figure 4-1:



Figure 4-1. Power on Interface

ShinewayTech: Logo of Shineway Technologies, Inc.
 palmOTDR-XXXX: Model
 ---Version X.X---: Software Version.

Three seconds after power on, the interface will be automatically directed to quick reference:

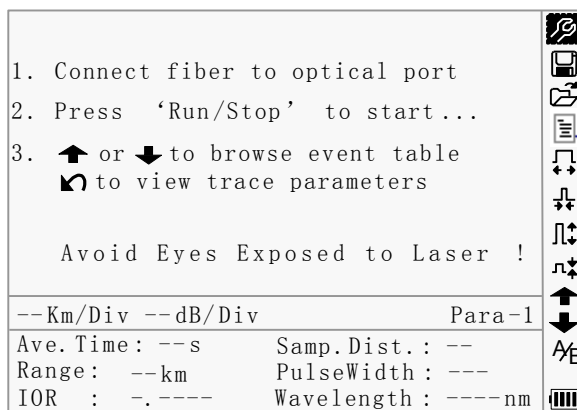

Figure 4-2. Quick Reference

4.2 Trace Measurement of palmOTDR

One complete trace can be obtained for each measurement. Also, palmOTDR can load a saved trace.

NOTE

- Before each measurement, if the operator is not familiar with the cautions, please do follow instructions in this manual for personal safety
- Make sure that the optical fiber or cable is not in use and there is no laser beam in the fiber before testing via palmOTDR. Otherwise, it may result in imprecise test trace, even permanent damage for the palmOTDR

4.2.1 Trace Measurement- Connect Optical Fiber

Connect optic fiber to palmOTDR optic output directly, no tools needed.

- Clean connectors, for details please refer to chapter A
- Clean tie-ins and check whether they are FC/PC tie-ins or not
- Connect optic fiber to the instrument

4.2.2 Trace Measurement - Parameter Configuration

For details relating to parameter configuration, please refer to 3.4.3.2, *Parameter Configuration on palmOTDR Menu Bar*. If the parameters are unclear, please use the default parameters of the instrument, however, this may cause an increase of measurements errors.

NOTE

Range is set to "Auto", when auto measurement is on.

4.2.3 Trace Measurement- Auto

Auto measurement can be applied in case that the length of optic fiber is unidentifiable. palmOTDR auto select adequate range for measurement.

Steps for Auto measurement:

- Parameter configuration: for detailed operations, please refer to 3.4.3.2, *Parameter Configuration on palmOTDR Menu Bar*. Set range to "AUTO"
- Measure: press [Run/Stop] to start measurement, and the interface is as in Figure 4-3. (a), (b)

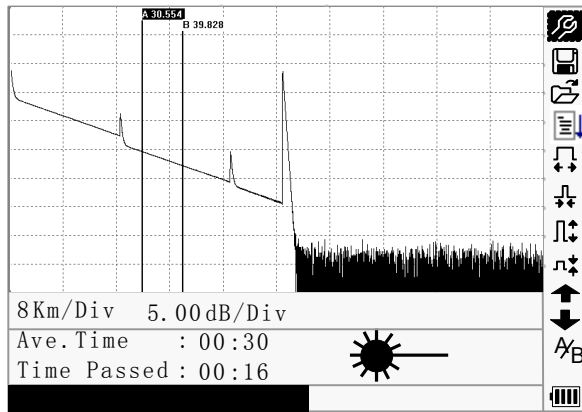

Figure 4-3.(a) Measuring

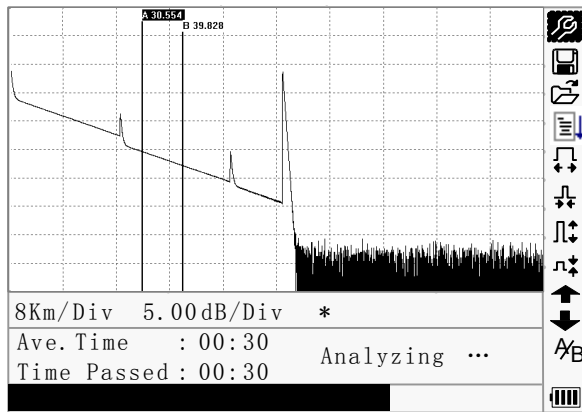

Figure 4-3.(b) Measuring

- Interface:
 - “Total: 00: 30” ----- Measure time which is set by user is 30 seconds
 - “Passed: 00: 16” ----- Total measurement time has passed 16 seconds
 - “☀” ----- Flickering of this sign means laser is active

NOTE

- After a certain period of time, the trace displays on the GUI. The trace in the Figure below is a trace during measurement, which will be refreshed for every certain period of time to demonstrate the whole process to users in real time. But at the end of measurement, the trace will be final, as shown in Figure 4-4.

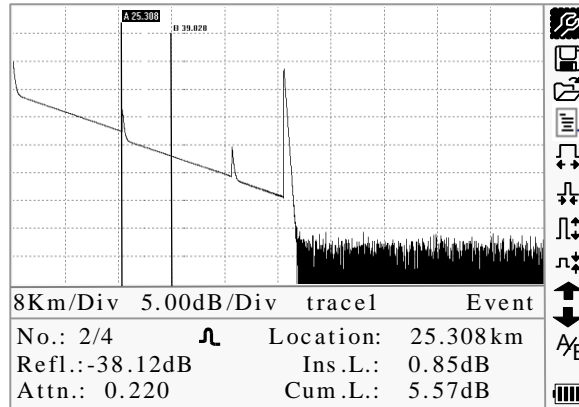



Figure 4-4. Trace Measurement of palmOTDR

4.2.4 Trace Measurement - Manual

If the operators have full knowledge of measured optic fiber, they can set accurate parameters, and achieve optimal measurement results.

- Change “range”: Refer to 3.4.3.2.2 range configuration to select adequate range
- Measure: Press  [Run/Stop] to start measurement. The process is the same with Auto measurement

4.2.5 Trace Measurement -Reasons of Measurement Failures

If measurement failures occur, reasons may be one of the following:

- Events may be too close to each other
Shorten the pulse width, and make another try. If failure still occurs, please try to measure at the other end of the optic fiber
- Low SNR
Try to use wider pulse or increase average time, and make another try
- Incorrect parameter configuration
Check parameter configuration, and make another try

4.3 Information Window

Items of information window: measurement parameters, analysis parameters, and information regarding marker A/B.





For details regarding information window, please refer to 3.4.2 palmOTDR information window.

4.3.1 Switch between Information Window Items

Under GUI of Figure 4-4., press [] and the items of information window will display in circulation: measurement parameter→ analysis information→ Event list→ information of marker A/B →fiber →measurement parameter.



4.3.2 Review Event List



Under GUI of Figure 4-4, press [

Use [] and [] too highlight  or , then press [Enter] to review events list, 

4.3.3 Review Marker A/B Information



4.3.3.1 Switching between Marker A/B

Under GUI of Figure 4-4., use [] and [] to highlight ^{A/B}, and then press [Enter] to switch between marker A/B.

Use [] and [] to move marker A or B.





4.3.3.2 Information between Marker A/B

Under GUI of Figure 4-4., press [] switch information window to marker A/B.

Press [] or [] to change the position of marker A or B, and information of marker A/B will change accordingly in information window.

4.4 Zoom in Trace Horizontally

This function is designed for users to review details of every event more carefully.

- Under GUI of Figure 4-4.,use [] and [] to highlight , then press [Enter] to zoom in trace horizontally; or to zoom in trace horizontally by the combining hot key [+] in the keyboard

- Press [◀] or [▶] to move marker to the event point to be observed
- To examine information of event point ,please according to”4.3.3.1 Switching between Marker A/B”

4.5 Zoom out Trace Horizontally

This function is to zoom out trace horizontally.

Under GUI of Figure 4-4., use [▲] and [▼] to highlight , and press [Enter] to zoom out trace. or to zoom out trace horizontally by the combining hot key [Shift/⌘]+[◀] in the keyboard.

4.6 Zoom in Trace Vertically

This function is designed for users to review event points more carefully.

- Under GUI of 4-4, press [▲] and [▼] to highlight , then press [Enter] to zoom in vertically; or to zoom in trace vertically by the combining hot key [Shift/⌘]+[▲] in the keyboard
- Use [◀] and [▶] to mover marker to event point to be observed
- For details, please refer to 6.3.3.1 switching between Marker A/B



4.7 Zoom out Trace Vertically

This function is designed to zoom out trace vertically.

- Under GUI of Figure 4-4, press [▲] and [▼] to highlight , then press [Enter] to zoom out trace vertically. or to zoom out trace vertically by the combining hot key [Shift/⌘]+ [▼] in the keyboard.

4.8 Re-analyze the trace

While the test result at a certain threshold is not good enough, it can be re-analyzed by this function (to change the threshold). Please note that this function can be effective while the OTDR is disconnected from the fiber.

- Under parameter configuration menu, edit the threshold value you want, press  to exit parameter configuration menu, then press [] to re-analyze the

trace.

4.9 Save Trace

When auto or manual measurement is finished, the measurement trace can be saved. Contents of trace saved include: Trace curve, related information of trace.

- Under GUI of Figure 4-4., use [▲] and [▼] to highlight , and then press [Enter] to enter, as shown in Figure 4-5.

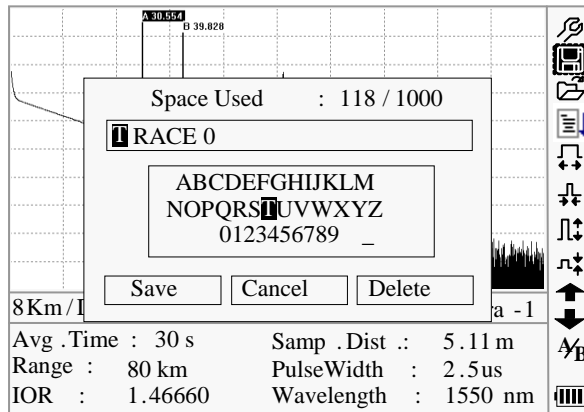



Figure 4-5. Save Trace

- Input filename: use [▲],[▼],[◀] and [▶] to choose the alphabet or Arabic numerals one by one, and press [Enter] to confirm. The length of filename will not exceed 8 characters of alphabet or Arabic numerals
- Save file: use [▲],[▼],[◀] and [▶] to highlight “OK”, press [Enter] to save
- Cancel saving file: use [▲],[▼],[◀] and [▶] to highlight “cancel”, press [Enter] to cancel the operation of “save file”
- Delete alphabet/Arabic numerals: use [▲],[▼],[◀] and [▶] to highlight “Delete”, press [Enter] to delete the alphabet/Arabic numerals
- Memory space: 118/1000 means that total memory space is 1000 files; it has already saved 118 files so far

4.10 Browse Saved Traces

Under GUI of Figure 4-4, use [▲] and [▼] to highlight , press [Enter] to confirm, as shown in Figure 4-6.

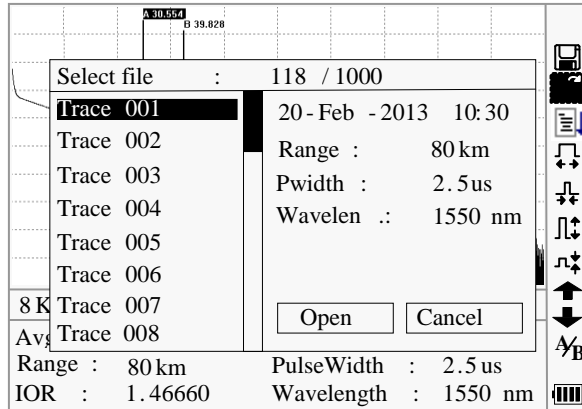

Figure 4-6. Browse Saved Traces

- Use [▲] and [▼] to highlight the certain trace, then use [◀] and [▶] to choose [Open] or [Cancel]; Press [Enter] to confirm
- Memory space: 118/1000 means that total memory space is 1000 files; it has already saved 118 files so far

4.11 Upload Saved Traces

Saved traces can be uploaded to PC through the associated software of trace manager or USB interface cable, with which traces can be further processed on PC.

- We suggest at first upload traces through USB interface cable:
 1. Connect PC and palmOTDR with USB interface cable;
 2. Power on palmOTDR;
 3. Click “Computer” on PC, find the “removable disk” and click it then enter into the “trace” document folder which saved measurement traces, you can freely copy, paste or delete them.
- Upload with RS232 interface cable:
 1. Install the software, and run
 2. Power off palmOTDR
 3. Connect palmOTDR to PC through RS232(or USB) interface cable
 4. Power on palmOTDR, and upload data with the software. The whole process is as in Figure 4-7.

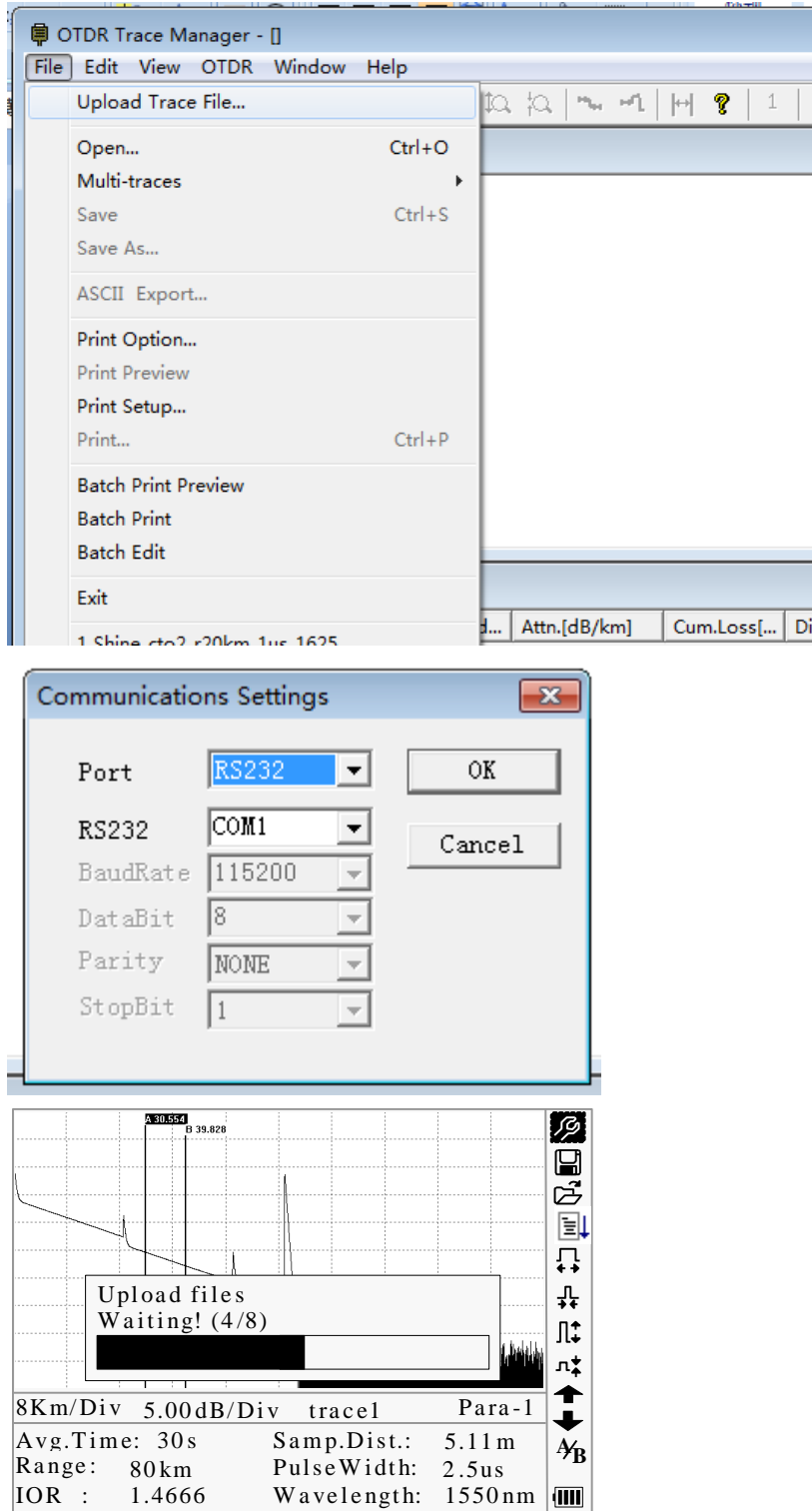



Figure 4-7. Upload Saved Traces

NOTE

- Make sure the instrument is power off when connecting to PC through RS232 (or USB) data cable; Make sure it's fastened, then power off.
- USB sustains the electrification hot plug. However USB operation rules must be obeyed while connecting to PC. To install USB driver correctly is necessary before uploading the data; Make sure USB is pulled out safely. Otherwise it will result in losing data.
- This operation cannot be applied under GUI of parameter configuration, save trace, browse saved traces, and measuring in progress.

4.12 Alter Measurement Parameters in Realtime Testing

To alter measurement in realtime testing, follow these steps:

- Use [▲] and [▼] to highlight “”, and then press [Enter]. A parameter will appear at the bottom of the screen.
- Use [◀] and [▶] to toggle between the parameters to be changed (Figure 4-8), and the press [Enter].
- Use [▲] and [▼] to change the Ref value. Select “Averaging” to select averaging testing.
- Press “OK” to exit the parameter configuration menu.

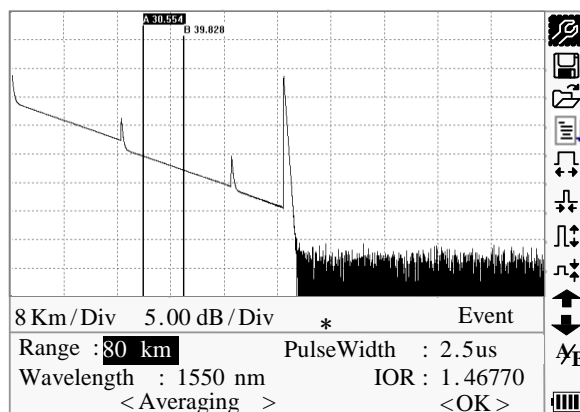

Figure 4-8. Real-time Testing

4.13 Power Meter and Laser Source Settings (Optional)

4.13.1 Optical Power Meter Settings

- Enter PM/LS interface as described in 3.4.3.2.7. Use [▲] and [▼] to highlight OPM, and press [Enter] to enter OPM interface as shown in Figure 4-9.



Figure 4-9. Optical Power Meter

- Use [◀] and [▶] to toggle between calibrated wavelengths. Press [Enter] to enter OPM measurement setting interface as shown in Figure 4-10.

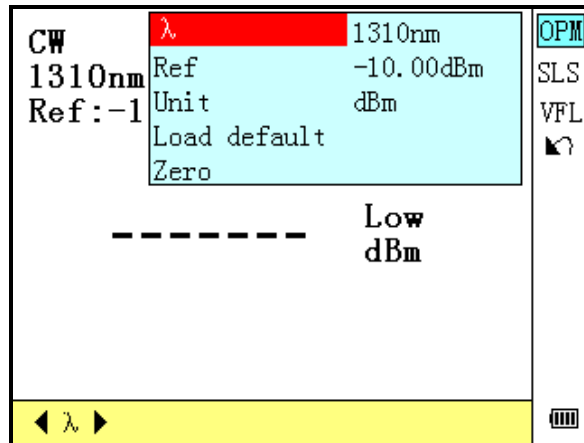

Figure 4-10. OPM Measurement Setting

- Use [▲] and [▼] to highlight the parameter to be adjusted, press [Enter] to enable adjustment. Press [◀] and [▶] to adjust digit position and press [▲] and [▼] to adjust the value. Press [Enter] again to confirm and press [↶] to quit setting.

4.13.2 Stabilized Laser Source Settings

- Enter PM/LS interface as described in 3.4.3.2.7. Use [▲] and [▼] to highlight SLS, and press [Enter] to enter SLS interface as shown in Figure 4-11.

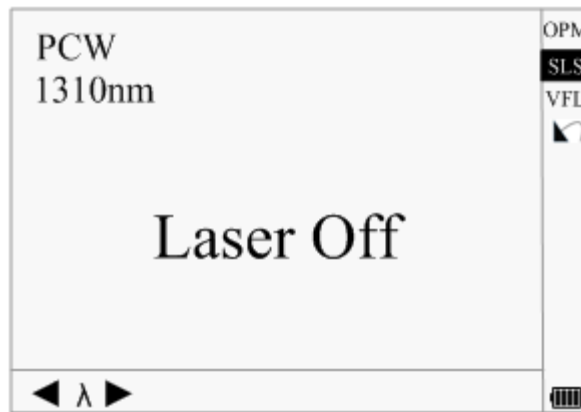

Figure 4-11. Stabilized Laser Source

- Use [◀] and [▶] to toggle between SLS working wavelengths. Press [Enter] to enter SLS setting interface as shown in Figure 4-12.

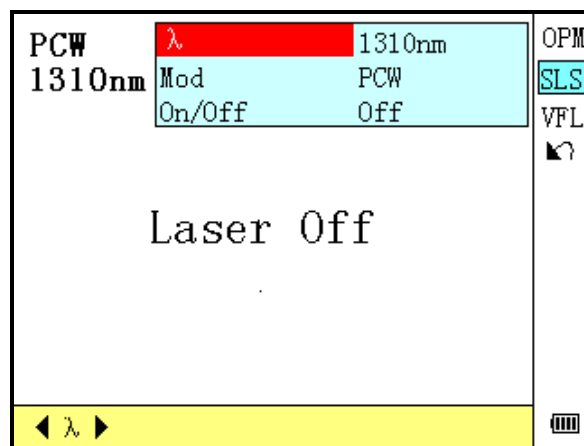

Figure 4-12. Stabilized Laser Source Setting

- Use [▲] and [▼] to highlight the parameter to be adjusted, press [Enter] to confirm and press [↵] to quit setting.

4.13.3 Visible Fault Locator Settings

- Enter PM/LS interface as described in 3.4.3.2.7. Use [▲] and [▼] to highlight VFL, and press [Enter] to enter VFL interface as shown in Figure 4-13.

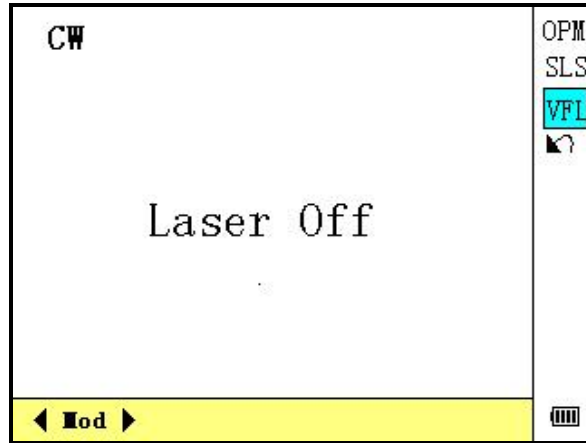

Figure 4-13. Visible Fault Locator

- Use [◀] and [▶] to toggle between VFL working modes. Press [Enter] to enter VFL setting interface as shown in Figure 4-14.

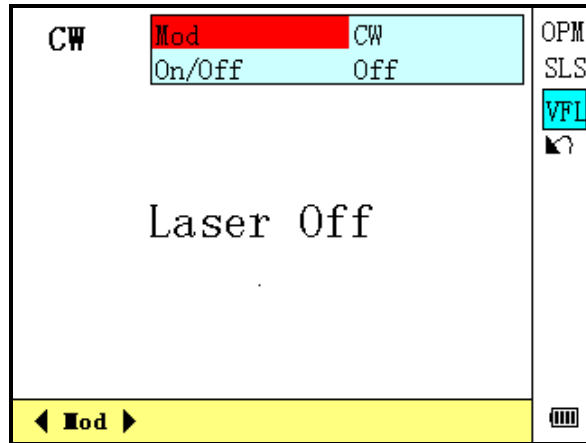

Figure 4-14. Visible Fault Locator Setting

- Use [▲] and [▼] to highlight the parameter to be adjusted, press [Enter] to confirm and press [↵] to quit setting.

4.13.4 PON Power Meter Settings

- Enter PM/LS interface as described in 3.4.3.2.7. Use [▲] and [▼] to highlight PPM, and press [Enter] to enter PPM interface as shown in Figure 4-15.

1310nm	PASS	PPM
-3.15 dBm		↩
1490nm	WRNG	
-20.76 dBm		
1550nm	PASS	
-3.29 dBm		
0.beijing	Save	☐

Figure 4-15. PON Power Meter

PPM interface displays the measured signal power values at 1310/1490/1550nm. It displays “Low” or “High” when measured value is beyond measurement range. Press [↩] to enable data saving function and press [↪] to quit PPM interface.

4.13.4.1 Saving Data

The [Save] icon at the bottom right corner of PPM interface will be highlighted when data saving function is enabled, as shown in Figure 4-16.

1310nm	PASS	PPM
-3.15 dBm		↩
1490nm	WRNG	
-20.76 dBm		
1550nm	PASS	
-3.29 dBm		
0.beijing	Save	☐

Figure 4-16. Data Saving Enabled

Press [Enter] to save measured data which will be filed as “record.csv” in “ppm” folder of palmOTDR internal memory. User can review test results from “record.csv file in both palmOTDR and PC.

Press [↩] to enable threshold setting as described below. Press [↪] or [▶] to return to PPM interface.

4.13.4.2 Threshold Setting

The threshold name will be highlighted when threshold setting is enabled as shown below:

1310nm	PASS	PPM
-3.15 dBm		↶
1490nm	WRNG	
-20.76 dBm		
1550nm	PASS	
-3.29 dBm		
0.beijing	Save	☐

Figure 4-17. Threshold Setting

palmOTDR-P series support 60 thresholds, user can save up to 20 measurement results under each threshold set. Threshold setting is saved in “threshold.csv” file in “ppm” folder of palmOTDR internal memory. Modification to “threshold.csv” file requires system reboot to take effect. If no threshold is set, system will create a threshold set with default settings.

Press [▲] and [▼] to modify threshold.

Press [▶] to enable save function, press [↶] to return to PPM interface.

4.13.4.3 Main Menu

In PPM interface, press [Enter] to enter PPM main menu as shown in Figure 4-18.

Menu	PPM
Unit W/dBm	↶
Reference	
Thre. Set	
Thre. View	
View Record	
Clear Record	
Auto Zero	
Default Set	
	▼ ▲ ☐

Figure 4-18. PPM Main Menu

The main menu includes Unit Setting (Unit W/dBm), Reference Setting (Reference), Threshold Setting (Thre. Set), Threshold Review (Thre. View), Record Review (View Record), Delete Record (Clear Record), Auto Zero and Load Default Setting (Default Set) functions. Press [▲] and [▼] to toggle between functions and press [Enter] to select.

4.13.4.3.1 Unit Setting (Unit W/dBm)

User can toggle between different measurement units as shown in Figure 4-19: dB, dBm and W, default unit is dBm.

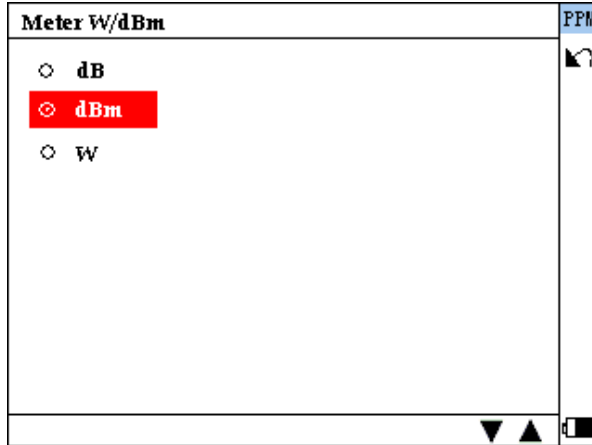

Figure 4-19 Unit Setting (Unit W/dBm)

4.13.4.3.2 Reference Setting (Reference)

User can set reference in below interface:

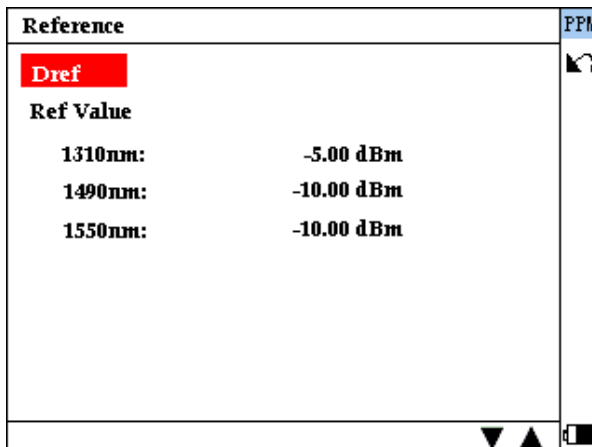

Figure 4-20 Reference Setting (Reference)

Select and run **Dref** to set current measured values as reference values (The measured values should be within the measurement range, e.g, not “Low” or “High”).

User can also modify the reference value of single wavelength.

The default reference value is shown in Figure 4-20: -5.0dBm@1310nm, -10.0dBm@1490nm and 1550nm.

Reference value is effective when “dB” is enabled as the measurement unit.

4.13.4.3.3 Threshold Setting (Thre. Set)

User can enable/disable threshold function by selecting and running “Thre. Set”. When such function is enabled, PPM will compare measured values with threshold settings and display PASS, FAIL or WRNG (Warning) accordingly. Threshold setting is on by default.

4.13.4.3.4 Threshold Review (Thre. View)

User can check threshold settings by selecting and running **Thre. View**, please select the threshold set (Test Station) to review.

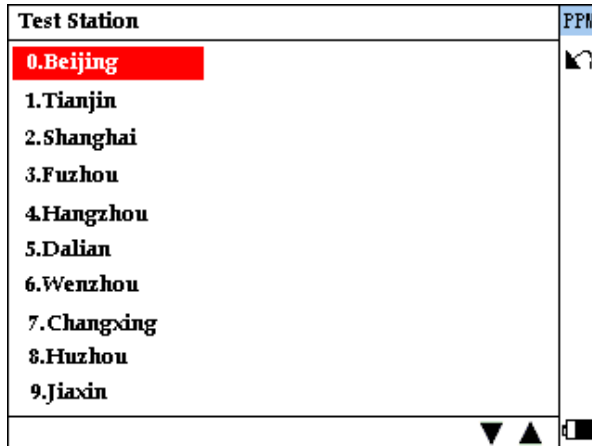
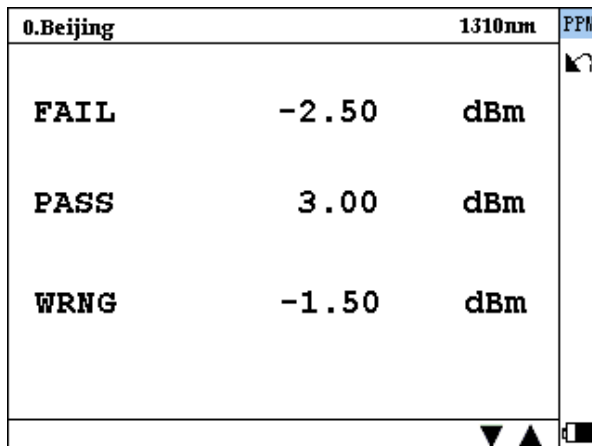

Figure 4-21 Reference Setting (Reference)



Select the threshold set(Test Station) and press **[Enter]** to review the threshold settings:



Switch the wavelength by [**▲**] and [**▼**].

4.13.4.3.5 Record Review (View Record)



User can check the saved record by selecting and running **View Record**, please select the test station to review.

0.Beijing		1/4	PPM
1310nm	-2.50	dBm	
1490nm	3.00	dBm	
1550nm	-1.50	dBm	
2011-12-15 16:34:23		▼ ▲	

The saved time is shown at the lower left corner of the interface. Switch the record by [▲] and [▼]. One test station can save 20 records.

4.13.4.3.6 Delete Record (Clear Record)

User can delete the record by selecting and running **Clear Record**. Please select the test station firstly. Press【shift+enter】to delete all records in this test station. Press 【enter】 to delete the record separately. The record in the test station is saved by time, as shown in the figure below.

Clear	PPM
2011-12-15 12:12:23	
2011-12-15 13:12:43	
2011-12-15 14:13:43	
2011-12-15 15:34:21	
2011-12-15 15:56:03	
2011-12-15 16:23:16	
2011-12-15 16:33:54	
2011-12-15 16:47:36	
2011-12-15 17:32:22	
2011-12-15 18:02:32	
	▼ ▲ 

Delete the record by selecting and pressing 【enter】

4.13.4.3.7 Auto Zero

Auto zero can be done by running this menu.

4.13.4.3.8 Load Default Setting (Default Set)

User can load the default setting by running **Default Set**.

5. Maintenance and Calibration

Maintenance and Replacing of Batteries

Battery for this instrument is rechargeable NiMH battery.

NOTE

Notes for maintenance of batteries in the instrument:

- In order for the palmOTDR (including the batteries) to meet specifications, the storage temperature should be within 15 °C to 30°C. And the instruments should be stored in low humidity environments
- If the instrument is left unused for a long time (idle for over 2 months), it is recommended to recharge the battery every other month
- As in figure 5-1, procedure of replacing battery is as follows.
 - a) Take off cover of the battery chamber
 - b) Remove the battery and draw out socket from the jack of chargeable battery, then change the battery if necessary
 - c) Remove the RTC clock battery, then change it if necessary

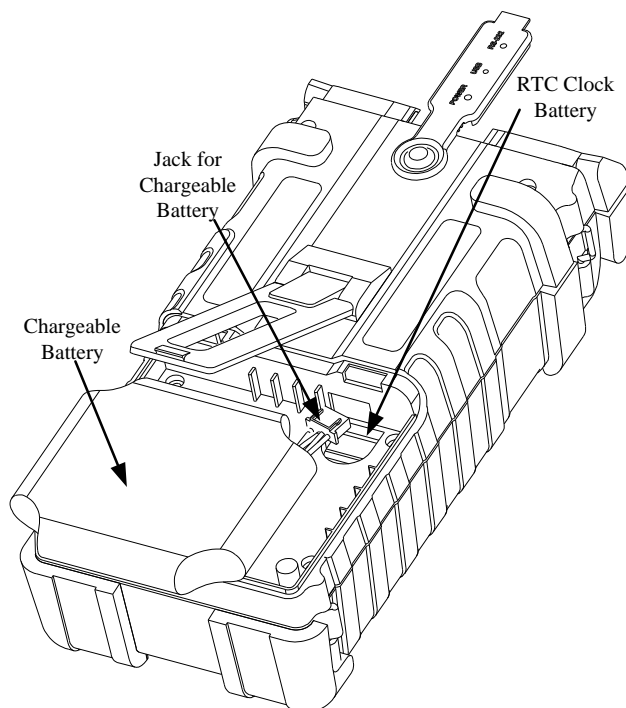

Figure 5-1. Replacing Battery

Cleaning of Interfaces

Interfaces must be kept clean. Special alcohol may be used to clean optic output. Always replace protective dust caps when the unit is not being used, and keep the protective dust caps clean.

In addition, flanges must be kept clean periodically,

➤ Effects of Cleaning Interfaces and Connectors

The diameter of optic core is 9um, and diameter of dust and other particulates ranges from 1/100 to 1/10 um. Comparatively speaking, the size of dust and other particulates can cover part of optic end and therefore degrade the performance of the instrument.

In addition, power density may burn dust into optic fiber and induce further damage(for example, 0dBm optic power may produce about 16000000W/m*m power density in single mode fiber). In this case, measurement will be inaccurate and irreversible.

➤ Safety instructions to be followed before cleaning

- a) Make sure the instrument is power off when cleaning
- b) Any operations contradict to the instructions may result in dangerous laser injuries
- c) Make sure laser source is off, when clean any optic connectors
- d) When the instrument is in operation, please always avoid looking directly into optic output. Although laser radiation is invisible, it may do serious injury to eyesight
- e) Be cautious of electric shock and make sure AC power is disconnected with the instrument before cleaning. Always use dry or moistest soft cloth to clean the outside of the instrument, and never clean the inside
- f) Please do not add any accessory to optic instrument or adjust the instrument at discretion
- g) For maintenance, always go to qualified or certified professionals

➤ Tools for Cleaning Interfaces and Connectors

- a) Optic fiber cleaner (for cleaning of optic connectors)
- b) Optic fiber cleaning rod (for cleaning of optic outputs)
- c) Optic fiber cleaning tissue (for cleaning optic interfaces)
- d) Isopropyl alcohol

- e) Cotton ball
- f) Paper tissue
- g) Cleaning brush
- h) Condensed air

➤ **Preferred Procedure for Cleaning Interfaces and Connectors**

As in Figure 5-2. Preferred Procedure is as follows:

- a) Screw off the cap of flange
- b) Clean the laser head carefully
- c) Screw on the cap of flange

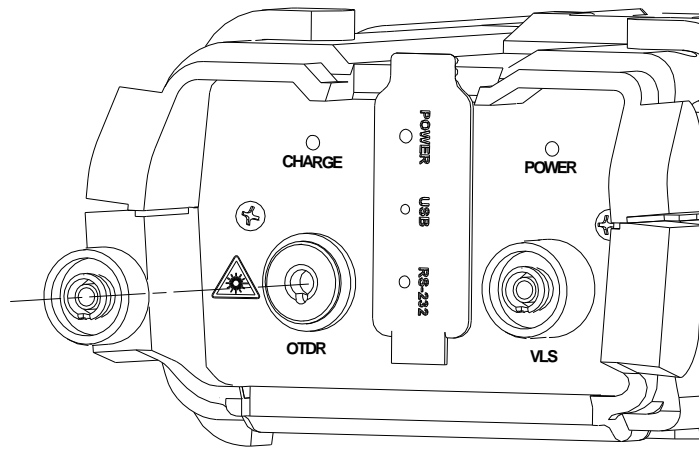

Figure 5-2. Structure of Flange

Calibration Requirements

Calibration of the instrument is recommended every two years. Please contact our representatives or nearby customer service centers for proper calibration.

6. Warranty Information

Terms of Warranty

All ShinewayTech® products are warranted against defective material and workmanship for a period of one (1) year from the date of shipment to the original customer. Any product found to be defective within the warranty period would be repaired or replaced by Shineway Technologies Inc. free of charge.

In no case will Shineway Technologies, Inc. liabilities exceed the original purchase price of the product.

Exclusions

The warranty on your equipment shall not apply to defects resulting from the following:

- *Unauthorized repair or modification*
- *Misuse, negligence, or accident*

Shineway Technologies, Inc. reserves the right to make changes to any of its products at any time without having to replace or change previously purchased units.

Warranty Registration

A warranty registration card is included with the original shipment of equipment. Please take a few moments to fill out the card and mail or fax it to the local Customer Service Center of Shineway Technologies, Inc. to ensure proper initiation of your warranty term and scope of your warranty.

Returning Instruments

To return instrument for reasons of yearly calibration or other, please contact the local Customer Service Center of Shineway Technologies, Inc. to obtain additional information and a RMA# (Return Materials Authorization number). And describe briefly reasons for the return of the equipment, to allow us offer you more efficient service.

NOTE

To return the instrument in the case of repair, calibration or other maintenance, please note the following:

- Be sure to pack the instrument with soft cushion like Polyethylene, so as to protect the shell of the instrument.
- Please use the original hard packing box. If use other packing material, please ensure at least 3 cm soft material around the instrument.
- Be sure to correctly fill out and return the warranty registration card, which should include the following information: company name, postal address, contact, phone number, email address and problem description.
- Be sure to seal the packing box with exclusive tape.
- Be sure to ship to your representative or the agent of the Company in a reliable way.

Contacting Customer Service

Please check our web site (www.shinewaytech.com) for updates to this manual and additional application information. If you need technical or sales support, please contact local **Shineway Technologies** Customer Service.

Shineway Technologies (China), Inc.:

Address: F1.7, Zhongtai Plaza, No.3 Shuangqing Rd, Haidian District, Beijing, China
Postal code: 100085
Tel: +86-10-62953388
Fax: +86-10-62958572
Email: support@shinewaytech.com
WEB: www.shinewaytech.com

**THANK YOU FOR CHOOSING
SHINEWAY TECHNOLOGIES!**

DOC. P/N: MAN-pOTDR.V110.10/10